

ICOM

INSTRUCTION MANUAL

UHF GMRS TRANSCEIVER
IC-F21GM

This device complies with Part 15 of the FCC rules. Operation is subject to the following two conditions: (1) This device may not cause harmful interference, and (2) this device must accept any interference received, including interference that may cause undesired operation.

Icom Inc.

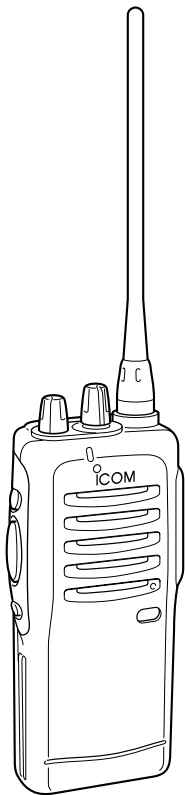

SAFETY TRAINING INFORMATION



Your Icom radio generates RF electromagnetic energy during transmit mode. This radio is designed for and classified as “Occupational Use Only”, meaning it must be used only during the course of employment by individuals aware of the hazards, and the ways to minimize such hazards.

This radio is NOT intended for use by the “General Population” in an uncontrolled environment.

This radio has been tested and complies with the FCC RF exposure limits for “Occupational Use Only”. In addition, your Icom radio complies with the following Standards and Guidelines with regard to RF energy and electromagnetic energy levels and evaluation of such levels for exposure to humans:

- FCC OET Bulletin 65 Edition 97-01 Supplement C, Evaluating Compliance with FCC Guidelines for Human Exposure to Radio Frequency Electromagnetic Fields.
- American National Standards Institute (C95.1 – 1992), IEEE Standard for Safety Levels with Respect to Human Exposure to Radio Frequency Electromagnetic Fields, 3 kHz to 300 GHz.
- American National Standards Institute (C95.3 – 1992), IEEE Recommended Practice for the Measurement of Potentially Hazardous Electromagnetic Fields – RF and Microwave.



To ensure that your exposure to RF electromagnetic energy is within the FCC allowable limits for occupational use, always adhere to the following guidelines:

- **DO NOT** operate the radio without a proper antenna attached, as this may damage the radio and may also cause you to exceed FCC RF exposure limits. A proper antenna is the antenna supplied with

this radio by the manufacturer or an antenna specifically authorized by the manufacturer for use with this radio.

- **DO NOT** transmit for more than 50% of total radio use time (“50% duty cycle”). Transmitting more than 50% of the time can cause FCC RF exposure compliance requirements to be exceeded. The radio is transmitting when the “TX indicator” lights red. You can cause the radio to transmit by pressing the “PTT” switch.
- **ALWAYS use** Icom authorized accessories (antennas, batteries, belt clips, speaker/mics, etc). Use of unauthorized accessories can cause the FCC RF exposure compliance requirements to be exceeded.
- **ALWAYS keep** the antenna at least 2.5 cm (1 inch) away from the body when transmitting and only use the Icom belt-clips, listed in p. 22, when attaching the radio to your belt, etc., to ensure FCC RF exposure compliance requirements are not exceeded. To provide the recipients of your transmission the best sound quality, hold the antenna at least 5 cm (2 inches) from your mouth, and slightly off to one side.

The information listed above provides the user with the information needed to make him or her aware of RF exposure, and what to do to assure that this radio operates within the FCC RF exposure limits of this radio.

Electromagnetic Interference/Compatibility

During transmissions, your Icom radio generates RF energy that can possibly cause interference with other devices or systems. To avoid such interference, turn off the radio in areas where signs are posted to do so. **DO NOT** operate the transmitter in areas that are sensitive to electromagnetic radiation such as hospitals, aircraft, and blasting sites.

Your Icom F21GM operates on GMRS frequencies (Plus 7 channels shared with FRS).

GENERAL MOBILE RADIO SERVICE (GMRS)

GMRS is a two-way personal radio service available to an individual (one man or one woman) to facilitate the activities of the individual's immediate family members. GMRS is not authorized for business uses.

Users must cooperate in the selection and use of channels to make the most effective use of them and reduce the possibility of interference. Channel 9 –15 are shared with FRS channels. You can communicate with any FRS radios on these 7 channels. FRS is a UHF two-way voice communication service for family, friends and associates to communicate among themselves within their neighbourhood and while on group outings. Eight GMRS channels are authorized for repeater operation*.

You must obtain a license for a GMRS system. Application is made on FCC Form 605 or on line at <http://www.fcc.gov/wtb/uls>. As of January, 2001, the license fee is \$85 for a 5-year term. Schedule F of the form permits immediate temporary operation during the application process. Form 605 and Form 159 remittance fee advice are available for downloading at <http://www.fcc.gov/formpage.html>.

Applications may be mailed to Federal Communications Commission, Wireless Bureau Applications, PO Box 358245, Pittsburgh, PA 15251-5245

Call 1-800-418 FORM to have the forms mailed to you, or call 1-202-418-0177 from your fax machine to have them faxed to you on the FCC Fax-On-Demand system. For assistance completing the forms call 1-800-CALL-FCC.

*Repeater use may require a subscription.



FOREWORD

Thank you for purchasing the IC-F21GM FM transceiver.

READ ALL INSTRUCTIONS carefully and completely before using the transceiver.

SAVE THIS INSTRUCTION MANUAL—This instruction manual contains important operating instructions for the transceiver.

IMPORTANT

⚠ **CAUTION! NEVER** hold the transceiver so that the antenna is very close to, or touching exposed parts of the body, especially the face or eyes, while transmitting. The transceiver will perform best if the microphone is 2 to 4 in. (5 to 10 cm) away from the lips and the transceiver is vertical.

⚠ **CAUTION! NEVER** operate the transceiver with a headset or other audio accessories at high volume levels.

⚠ **CAUTION! NEVER** short the terminals of the battery pack.

DO NOT push the PTT when not actually desiring to transmit.

AVOID using or placing the transceiver in direct sunlight or in areas with temperatures below -22°F (-30°C) or above $+140^{\circ}\text{F}$ ($+60^{\circ}\text{C}$).

DO NOT modify the transceiver for any reason.

KEEP the transceiver from the heavy rain, and **Never** immerse it in water. The transceiver construction is water resistant, not water-proof.

The use of non-Icom battery packs/chargers may impair transceiver performance and invalidate the warranty.

FCC caution: Changes or modifications to this transceiver, not expressly approved by Icom Inc., could void your authority to operate this transceiver under FCC regulations.

TABLE OF CONTENTS

SAFETY TRAINING INFORMATION	i-ii
ABOUT GMRS	iii
FOREWORD	v
IMPORTANT	v
TABLE OF CONTENTS	vi
1 PANEL DESCRIPTION	1-3
■ Switches, controls, keys and connectors	1-2
■ LED indicator	3
2 ACCESSORIES	4
3 BATTERY PACKS	5-11
■ Battery pack replacement	5
■ Battery cautions	6
■ Battery charging	7-9
■ Charging NOTE	10
■ Battery case (Option)	11
4 SET MODE	12-19
■ Set mode	12
5 OPERATION	20-22
■ Receiving and transmitting	20
■ Setting squelch level	22
■ Auto scan function	22
■ Wide/Narrow selection	22
6 OPTION	23-24

Icom, Icom Inc. and the  ICOM logo are registered trademarks of Icom Incorporated (Japan) in the United states, the United Kingdom, Germany, France, Spain, Russia and/or other countries.

1 PANEL DESCRIPTION

■ Switches, controls, keys and connectors

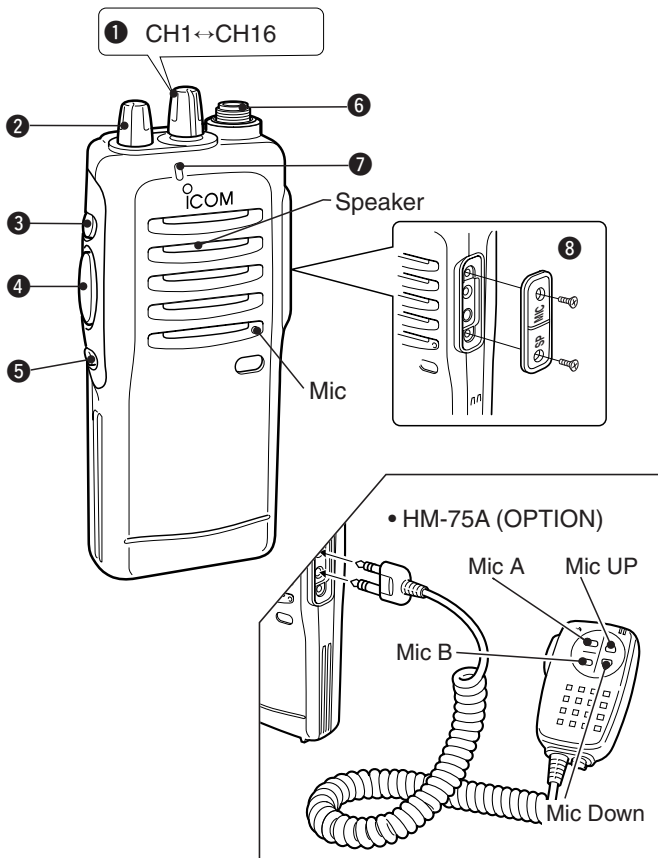

- ① **CHANNEL SELECTOR/SW [CH]** (p. 14)
Turn to select CH1 to CH16.
- ② **VOLUME CONTROL [OFF/VOL]**
Turns power ON and adjusts the audio level.
- ③ **MONITOR (Audi) key [MONI]** (p. 21)
 - Push and hold to open the noise/tone squelch.
 - Push to turn the noise/tone squelch ON.
- ④ **PTT SWITCH [PTT]**
Push and hold to transmit; release to receive.
- ⑤ **WIDE/NARROW KEY [W/N]** (p. 22)
 - Push to select Wide FM mode.
 - Push and hold to select Narrow FM mode.
- ⑥ **ANTENNA CONNECTOR**
Connects the supplied antenna.
- ⑦ **TX/RX INDICATOR LED** (p. 3)
 - Lights red while transmitting.
 - Lights green while receiving a signal, or squelch is open.
- ⑧ **[SP]/[MIC] JACK**
Connects optional speaker-microphone.

◇ **HM-75A Speaker Microphone key reference (OPTION)***

Mic Up	Push and hold to open the noise/tone squelch.
Mic Down	Same as [W/N] key. (p. 22)
Mic A	Push to start/stop scan function. (P. 22)
Mic B	Push several times to select output power; Low1, Low2 and High. (p. 13)

*These functions are available when the optional Speaker/Mic. is connected.

1 PANEL DESCRIPTION

■ LED indicator

The TX/RX indicator LED indicates information in several ways as follows;
(Ref.; R=Red, G=Green)

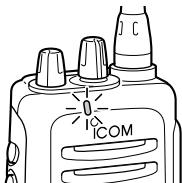

- TX: Turns Red while transmitting a signal.



- RX: Turns Green while receiving a signal.



- Low BATT1: You should charge the battery. (blinks slowly)



- Low BATT2: You must charge the battery. (blinks fast)

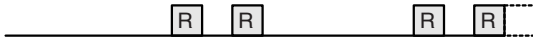

- TX low BATT1: Low BATT1 was detected during TX mode.



- TX low BATT2: Low BATT2 was detected during TX mode.



- Auto scan: LED blinks during scan operation. (p. 22)

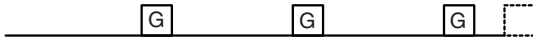

CAUTION:

- Low BATT3: If you did not charge the battery after Low BATT2 warning has appeared, the Low BATT3 warning beep emits for 15 sec. then the power turns OFF automatically.

■ Accessory attachment

◇ Supplied accessories

The transceiver comes supplied with the following accessories.

- ① Flexible antenna
- ② Belt clip

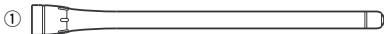

◇ Antenna

The antenna screws onto the transceiver as illustrated at right.

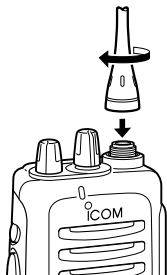

◇ Belt clip

Attach the belt clip to the transceiver as illustrated below.

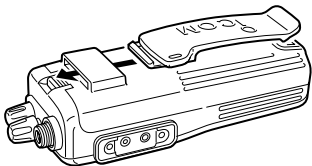
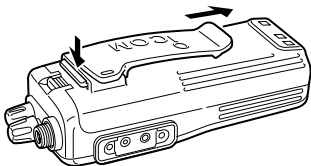

3 BATTERY PACKS

■ Battery pack replacement

Before replacing the battery pack, the volume control **MUST** be rotated fully counterclockwise, until a click is heard, to **turn the power OFF**.

- Push the battery release forward, then pull the battery pack upward with the transmitter facing you.

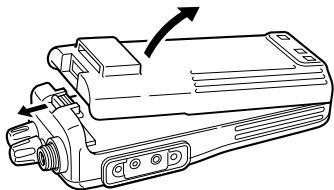

◇ BATTERY PACKS

Battery pack	Voltage	Capacity	Charging period		Operating period* ¹
			BC-146	BC-144, BC-119 or BC-121	
BP-208* ²	Battery case for AA (R6) × 6 alkaline				
BP-209	7.2 V	1100 mAh	12 hrs	1.5 hrs	8 hrs
BP-210	7.2 V	1650 mAh	18.5 hrs	2.0 hrs	11 hrs
BP-222* ³	7.2 V	600 mAh	6.5 hrs	1 hr	5.5* ³ hrs

*¹ Operating periods are calculated under the following conditions;
Tx : Rx : standby = 5 : 5 : 90

*¹ Operating period depends on the alkaline cells used. (BP-208 only)

*² Output power is automatically reduced to 1 W to retain sufficient power in case of an emergency, etc.

*³ Operating period measured with the 2 W model.

■ Battery cautions

- **CAUTION! NEVER** short the terminals of the battery pack (or charging terminals of the transceiver). Also, current may flow into nearby metal objects such as a necklace, so be careful when placing battery packs (or the transceiver) in handbags, etc. Simply carrying with or placing near metal objects such as a necklace, etc. causes shorting. This will damage not only the battery pack, but also the transceiver.
- **NEVER** incinerate used battery packs. Internal battery gas may cause an explosion.
- **NEVER** immerse the battery pack in water. If the battery pack becomes wet, be sure to wipe it dry **BEFORE** attaching it to the transceiver.
- **Clean** the battery terminals to avoid rust or miss contact.
- **Keep** battery contacts clean. It's a good idea to clean battery terminals once a week.

If your battery pack seems to have no capacity even after being charged, completely discharge them, then fully charge the battery pack again. If the battery pack still does not retain a charge (or only very little charge), a new battery pack must be purchased.

◇ Recycling information (U.S.A. only)



The battery (BP-209, BP-210 or BP-222) that you have purchased is recyclable. At the end of its life, under various state and local laws, it may be illegal to dispose of this battery into the municipal waste stream. Call 1-800-822-8837 for battery recycling options in your area or contact your dealer.

3 BATTERY PACKS

■ Battery charging

◇ Rapid charging with the BC-144+AD-99

The optional BC-144 provides rapid charging of optional battery packs.

The following are additionally required:

- One AD-99 (depends on version.).
- An AC adaptor (may be supplied with the BC-144 depending on version).

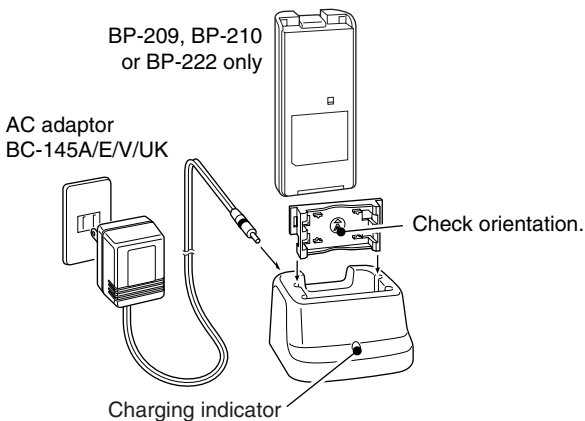

◇ Rapid charging with the BC-144+AD-99

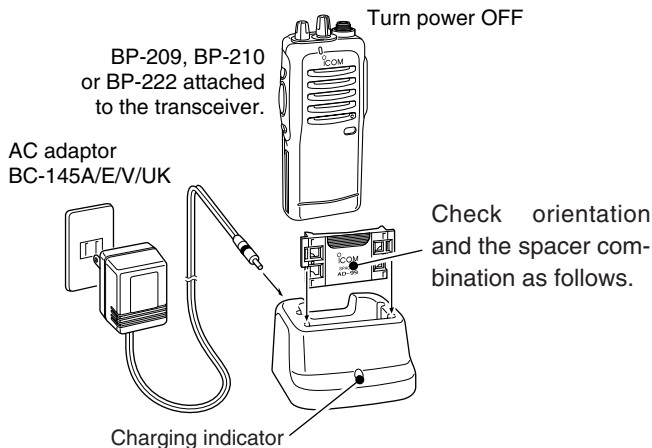

◇ Spacer combination.

- Be sure to attach the spacer (Spacer B/C) to the adaptor (Spacer A) with the orientation as illustrated in the diagram at right.
- Attach the spacer (Spacer B/C) to the adaptor with the orientation of the stamp “**C**” pointing up.

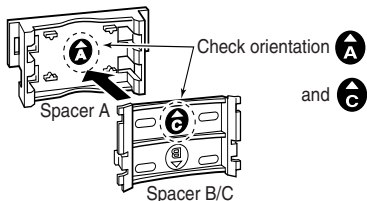

NOTE: Push the notch carefully when removing the spacer from the adaptor.

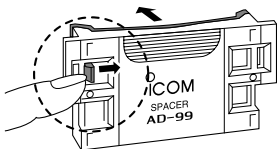

3 BATTERY PACKS

◇ Rapid charging with the BC-121+AD-94 (#11)

The optional BC-121 allows up to 6 battery packs to be charged simultaneously. The following are additionally required.

- Six AD-94 (#11) (Some versions require additional AD-99s).
- An AC adaptor (may be supplied with the BC-121 depending on version).

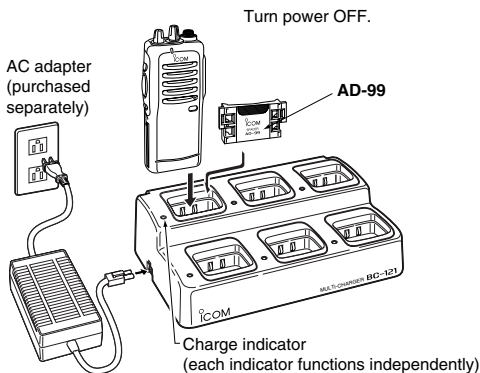

◇ Regular charging with the BC-146

The optional BC-146 provides regular charging of optional battery pack with/without transceiver.

The following is additionally required:

- An optional AC adaptor. (A charging spacer is supplied with BC-146.)

Turn power OFF.

Check orientation for correct charging. (Insert together with charging adapter.)

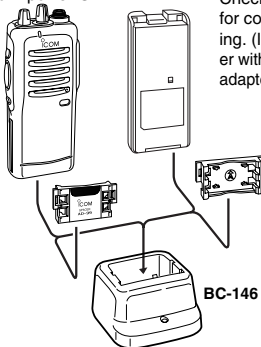

■ Charging NOTE

Prior to using the transceiver for the first time, the battery pack must be fully charged for optimum life and operation.

- Recommended temperature range for charging:
+10°C to +40°C (50°F to 140°F).
- Use the supplied charger or optional charger (BC-119/BC-121/BC-144 for rapid charging, BC-146 for regular charging) only. **NEVER** use other manufacturers' chargers.

The optional BP-209, BP-210 or BP-222 battery packs include rechargeable Ni-Cd(Ni-MH: BP-210) batteries and can be charged approx. 300 times. Charge the battery pack before first operating the transceiver or when the battery pack becomes exhausted.

If you want to charge the battery pack more than 300 times, the following points should be observed:

- **Avoid overcharging**—batteries must be removed from the charger to stop charging. Batteries should not be charged for more than 15 hours after the LED indicator turns green.
- Use the battery until it becomes almost completely exhausted under normal conditions.

◇ Battery pack life

When the operating period becomes extremely short even after charging the battery pack fully, a new battery pack is needed.

NOTE: The charger rapidly charges a battery pack to a specified level, not a completed level, to prevent overcharging. Leave the battery pack in the charger for a few more hours (up to 15 hours; depending on battery condition) after the LED indicator turns green, to charge the battery completely.

3 BATTERY PACKS

■ Battery case (Option)

When using a BP-208 OPTIONAL BATTERY CASE attached to the transceiver, install 6 AA (R6) size alkaline batteries as illustrated below.

NOTE: Output power is automatically reduced to **1 W** to retain sufficient power in case of an emergency, etc.

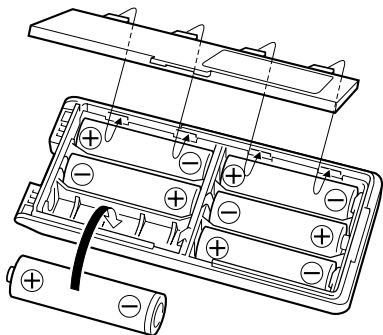

◆ CAUTIONS

- Use **ALKALINE** batteries only.
 - **Make sure** all battery cells are the same brand, type and capacity.
 - **Never** mix old and new batteries.
- Either of the above may cause a fire hazard or damage the transceiver, if ignored.
- **Never** incinerate used battery cells since internal battery gas may cause them to rupture.
 - **Never** expose a detached battery case to water.
- If the battery case gets wet, be sure to wipe it dry before using it.

■ Set mode

Set mode is used for programming infrequently changed values or conditions of functions.

- All settings performed with [CH selector], [OFF/VOL], [MONI], [PTT] and [W/N] keys.

◇ SELECTING RF OUTPUT POWER

The RF output can be selected from one of 3 modes. (p. 13)

◇ SETTING THE SIMPLEX/DUPLEX OPERATION

The Simplex/Duplex function changes duplex operation to simplex operation. (pgs. 13–14)

◇ SETTING THE CTCSS TONE FREQUENCY

CTCSS (Continuous Tone Coded Squelch System) encoder/decoder are standard, providing quiet stand-by. (pgs. 15–16)

◇ CTCSS FIND

This transceiver can detect the CTCSS tone frequency in the received signal. (p. 19)

◇ SETTING THE DTCS CODE

DTCS (Digital Tone Coded Squelch system) encoder/decoder are standard, providing quiet stand-by. (pgs. 17–18)

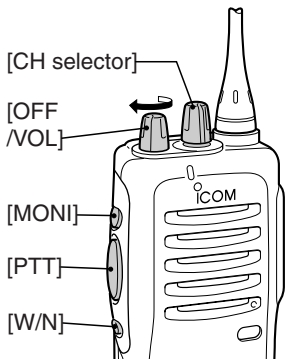

2 CHAPTER CONTINUED

◆ SELECTING RF OUTPUT POWER

The transceiver has 3 output power levels to suit your operating requirements. Low output power settings during short-distance communications may reduce the possibility of interference to other stations, and will reduce current consumption.

- ① While pushing and holding [PTT], [MONI], turn [OFF/VOL] to power ON.
- ② Push [MONI] to toggle between Low1 (1 W ; Pi), Low2 (2 W ; PiPi) and High (4 W ; PiPiPi).
- ③ Turn the power OFF, and then ON again.

◆ SETTING THE SIMPLEX/DUPLEX OPERATION

The Simplex/Duplex function changes duplex channels to simplex channels.

- ① While pushing and holding [PTT], [MONI], turn [OFF/VOL] to power ON.
 - ② Turn CH selector knob to select the desired channel.
 - ③ Push [W/N] to turn the simplex mode ON.
 - A beep (Pi) is emitted.
- or
- ③ Push and hold [W/N] to turn the duplex mode ON.
 - A long beep (Pii) is emitted.
 - ④ Turn the power OFF, and then ON again.

NOTE: Duplex mode is available between CH 1 to CH 8. (see right.)

• **Frequency channel list**

No.	Rx/Tx Freq.* ¹	Tx Freq.* ²	Wide/Narrow	Note
1	462.5500	467.5500	Narrow	
2	462.5750	467.5750	Narrow	White
3	462.6000	467.6000	Narrow	
4	462.6250	467.6250	Narrow	Black
5	462.6500	467.6500	Narrow	
6	462.6750	467.6750	Narrow	Orange
7	462.7000	467.7000	Narrow	
8	462.7250	467.7250	Narrow	
9	462.5625	-----	Narrow	
10	462.5875	-----	Narrow	
11	462.6125	-----	Narrow	
12	462.6375	-----	Narrow	
13	462.6625	-----	Narrow	
14	462.6875	-----	Narrow	
15	462.7125	-----	Narrow	
16	Auto Scan	-----	-----	

(Unit: MHz)

*1: Simplex operation/Duplex receive frequency

*2: Duplex transmit frequency

Wide/Narrow: Wide FM/Narrow FM (default)

4 SET MODE

◆ SETTING THE CTCSS TONE FREQUENCY

This transceiver is equipped with 52 CTCSS codes. (See right.) CTCSS operation provides communication with silent standby since you will only receive calls from group members using the same CTCSS number.

You can assign different numbers to CH 1 to CH 15 independently.

- ① While pushing and holding [PTT], [MONI], [W/N], turn [OFF/VOL] to power ON.
- ② Select the desired CH 1 to CH 15 that you want to assign the CTCSS tone frequency to.
- ③ Push and hold [MONI] until a beep (Pi) is emitted.
- ④ Push [PTT] the necessary number of times to choose the 10 digit of the desired channel from the channel list.
- ⑤ Push [MONI].
 - Confirmation beep is emitted. (See p. 17)
- ⑥ Push [PTT] the necessary number of times to choose the 1 digit of the desired channel from the frequency list.
- ⑦ Push [MONI].
- ⑧ Turn the power OFF, and then ON again.

[Example]

To assign No. 28 as CH1;

- ① While pushing and holding [PTT], [MONI] and [W/N], turn [OFF/VOL] to power ON.
- ② Select the CH 1.
- ③ Push and hold [MONI] until a beep (Pi) is emitted.
- ④ Push [PTT] twice to choose the 10 digit of the desired channel.
- ⑤ Push [MONI].
- ⑥ Push [PTT] eight times to choose the 1 digit of the desired channel.
- ⑦ Push [MONI].
- ⑧ Turn the power OFF, and then ON again.

• CTCSS tone code list

No.	Freq.*	No.	Freq.*	No.	Freq.*	No.	Freq.*
0	OFF	16	107.2	32	171.3	48	233.6
1	67.0	17	110.9	33	173.8	49	241.8
2	69.3	18	114.8	34	177.3	50	250.3
3	71.0	19	118.8	35	179.9	51	254.1
4	71.9	20	123.0	36	183.5	52	270.4
5	74.4	21	127.3	37	186.2		
6	77.0	22	131.8	38	189.9		
7	79.7	23	136.5	39	192.8		
8	82.5	24	141.3	40	196.6		
9	85.4	25	146.2	41	199.5		
10	88.5	26	151.4	42	203.5		
11	91.5	27	156.7	43	205.5		
12	94.8	28	159.8	44	210.7		
13	97.4	29	162.2	45	218.1		
14	100.0	30	165.5	46	225.7		
15	103.5	31	167.9	47	229.1		

(Unit: Hz)

: EIA/TIA standard code (Recommended to use these.)

4 SET MODE

◆ SETTING THE CTCSS TONE FREQUENCY (continued)

• CTCSS confirmation beep

Push [PTT]	Confirmation beep	Push [PTT]	Confirmation beep
no	●	5 (Fifth)	●●●●●
1 (Once)	●	6 (Sixth)	▬ ●
2 (Twice)	●●	7 (Seventh)	▬ ●●
3 (Third)	●●●	8 (eighth)	▬ ●●●
4 (Fourth)	●●●●	9 (ninth)	▬ ●●●●

●; Single beep

▬ ; Long beep

◆ SETTING THE DTCS CODE

This transceiver is equipped with 83 DTCS codes. DTCS operation provides communication with silent standby since you will only receive calls from group members using the same DTCS number. You can assign different numbers to CH 1 to CH 15 independently.

- ① While pushing and holding [PTT], [MONI], [W/N], turn [OFF/VOL] to power ON.
- ② Select the desired CH 1 to CH 15 that you want to assign the DTCS code to.
- ③ Push and hold [W/N] until a beep (Pi) is emitted.
- ④ Push [PTT] the necessary number of times to choose the 100 digit of the desired code number.
- ⑤ Push [MONI].
 - Confirmation beep is emitted. (See p. 17)
- ⑥ Push [PTT] the necessary number of times to choose the 10 digit of the desired code number.
- ⑦ Push [MONI].
 - Confirmation beep is emitted. (See p. 17)
- ⑧ Push [PTT] the necessary number of times to choose the 1 digit of the desired code number.
- ⑨ Push [MONI].

- Confirmation beep is emitted. (See p. 17)
- ⑩ Push [PTT] once more, if you want to use **Inverse** mode.
- ⑪ Push [MONI] to complete the setting.
 - Confirmation beep is emitted. (See p. 17)
- ⑫ Turn the power OFF, and then ON again.

[Example]

To assign code '261 (normal)' as CH12;

- ① While pushing and holding [PTT], [MONI], [W/N], turn [OFF/VOL] to power ON.
- ② Select CH 12.
- ③ Push and hold [W/N] until a beep (Pi) is emitted.
- ④ Push [PTT] twice to choose the 100 digit of the code number.
- ⑤ Push [MONI].
 - Confirmation beep is emitted. (See p. 17)
- ⑥ Push [PTT] six times to choose the 10 digit of the code number.
- ⑦ Push [MONI].
 - Confirmation beep is emitted. (See p. 17)
- ⑧ Push [PTT] once to choose the 1 digit of the code number.
- ⑨ Push [MONI].
 - Confirmation beep is emitted. (See p. 17)
- ⑩ Push [MONI] to complete the setting.
 - Confirmation beep is emitted. (See p. 17)
- ⑪ Turn the power OFF, and then ON again.

• DTCS code list

023	071	134	223	306	411	503	631	734
025	072	143	226	311	412	506	632	743
026	073	152	243	315	413	516	654	754
031	074	155	244	331	423	532	662	
032	114	156	245	343	431	546	664	
043	115	162	251	346	432	565	703	
047	116	165	261	351	445	606	712	
051	125	172	263	364	464	612	723	
054	131	174	265	365	465	624	731	
065	132	205	271	371	466	627	732	

4 SET MODE

◆ CTCSS FIND

This transceiver can detect the CTCSS tone frequency in the received signal. By monitoring a signal that is being transmitted from the other station, you can determine the tone frequency required to communicate with them.

This function very useful when you are going to communicate with unknown CTCSS channel number stations. 'CTCSS FIND' scans all of the CTCSS channels, then stops when a tone frequency is detected.

- ① While pushing and holding [MONI], [W/N], turn [OFF/VOL] to power ON.
- ② Select the desired CH 1 to CH 15 that you want to assign the CTCSS tone frequency.
- ③ Push and hold [MONI] until a beep (Pi) is emitted.
 - 'CTCSS FIND' start to scan the signal.
- ④ 'CTCSS FIND' stops when the tone signal is detected.
- ⑤ Push [MONI] to determine the tone number.
- ⑥ Turn the power OFF, and then ON again.

■ Receiving and transmitting

NOTE: Transmitting without an antenna may damage the transceiver. See p.4 for antenna attachment.

Turn power ON as described on p. 2.

Program the SIMPLEX/DUPLEX OPERATION and CTCSS /DTCS tone number (select CH 0 if you will not use the CTCSS function) before operation.

Receiving:

- ① Select the desired channel.
- ② Listen for a transmission and adjust [VOL] to a comfortable listening level.
 - When no transmission is heard, push and hold [MONI] while adjusting [VOL].

The transceiver is now set to receive desired calls on the selected channel.

Transmitting:

Wait for the channel to become clear to avoid interference.

- ③ While pushing and holding [PTT], speak into the microphone at a normal voice level.
- ④ Release [PTT] to return to receive.

IMPORTANT: To maximize the readability of your transmitted signal, pause a few sec. after pushing [PTT], hold the microphone 10 to 15 cm from your mouth and speak at a normal voice level.

5 OPERATION

◇ MONITOR AUDIBLE FUNCTION

The monitor function allows you to open the transceiver's squelch manually to check whether a channel is busy or not. The transceiver has 2 conditions for receive standby:

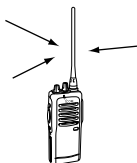

All signals are received

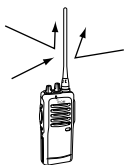

Only signals containing the proper tone are received

Audible condition:

This condition mutes audio ONLY when no carrier is present. You can receive (or monitor) any signals on a channel.

- Push and hold the [MONI], switch to select the audible condition.

Any audio mute functions are cancelled while pushing the [MONI] switch.

Inaudible condition:

This condition mutes ALL signals except those directed to you. Therefore you should check a channel's condition (busy or not) with the monitor function before transmitting.

- Push the [MONI] switch momentarily to select the inaudible condition.

◇ TIME-OUT TIMER

After continuous transmission for a pre-programmed period, the time-out timer is activated, causing the transceiver to stop transmitting and automatically selects receive.

- The time-out timer function is automatically turned ON when 3 min. has passed.

◇ POWER SAVE FUNCTION

The power save function reduces the current drain to conserve battery power.

- The power save function is automatically turned ON when no operation is performed or no signal is received for 5 sec.

■ Setting squelch level

The squelch circuit mutes the received audio signal depending on the signal strength. Scan proceeds in sequence from lower channel to higher channel numbers.

- ① While pushing [PTT] and [W/N], turn the transceiver's power on to enter the squelch adjustment mode.
- ② Push [MONI] to increase the squelch level (tight squelch) or [W/N] to decrease the squelch level (loose squelch).
 - Squelch level will be fixed after 1 sec.

■ Auto scan function

Auto scan function proceeds in sequence from lower channel to higher channel numbers. Scanning searches for signals automatically and makes it easier to locate new stations for contact or listening purpose.

- ① Turn the CH select knob to CH 16. Scan starts automatically.
 - When receiving a signal, scan pauses until a signal disappears.

NOTE: You can perform the scan start/stop by optional HM-75A SPEAKER-MICROPHONE' [Mic A] key.

■ Wide/Narrow selection

You can easily to toggle between wide FM mode and narrow FM mode by pushing [W/N] key.

- Push [W/N]: Turns to wide FM mode.
- Pushing and holding [W/N]: Turns to narrow FM mode.

6 OPTION

Options

◇ BATTERY PACKS

• BP-208 BATTERY CASE

Allows a set of Alkaline batteries to operate the handheld when charging the rechargeable battery or in emergencies, etc. 6 AA (R6) cells are required.

• BP-209 Ni-Cd BATTERY PACK

7.2 V/1100 mAh Ni-Cd battery pack, allows more than 8 hours operation.

• BP-210 Ni-MH BATTERY PACK

7.2 V/1650 mAh Ni-MH battery pack, allows approx. 11 hours operation.

• BP-222 Ni-Cd BATTERY PACK

7.2 V/600 mAh Ni-Cd battery pack, allows approx. 5.5* hours operation (Same as supplied with 2 W models).

*When used with 2 W model.

◇ CHARGER

• BC-119 DESKTOP CHARGER + AD-94 (#11)

For rapid charging of battery packs. An AC adaptor is supplied with the charger. Charging time: 1.5 to 2 hrs.

• BC-121 MULTI-CHARGER + AD-94 (#11)

For rapid charging up to 6 battery packs simultaneously. An AC adaptor may be supplied depending on version. Six AD-94's (#11) are necessary. Charging time: 1.5 to 2 hrs.

• AD-99 CHARGER ADAPTOR

• BC-144 DESKTOP CHARGER

For rapid charging of BP-209 (Ni-Cd), BP-210 (Ni-MH) and BP-222 (Ni-Cd).

• BC-146 DESKTOP CHARGER

For regular charging of BP-209 (Ni-Cd), BP-210 (Ni-MH) and BP-222 (Ni-Cd).

◇ OTHER OPTIONS**• HM-46L/HM-75A/HM-131L SPEAKER-MICROPHONES**

Combination speaker-microphone that provides convenient operation while hanging the transceiver from your belt.

HM-75A has programmable function key Mic Up, Mic Down, Mic A, Mic B.

HM-131L has moisture proof construction.

• HS-51 HEAD SET

Allows you hands-free operation. Includes PTT and TOT.

• SP-13 EARPHONE

Provides clear receive audio in noisy environments.

• MB-68 BELT CLIP

Same as that supplied with the transceiver.

• MB-74 BELT CLIP

Exclusive alligator-type belt clip.

• AD-98FSC ANTENNA CONNECTOR ADAPTOR

Allows you to connect a BNC-type antenna.

Count on us!

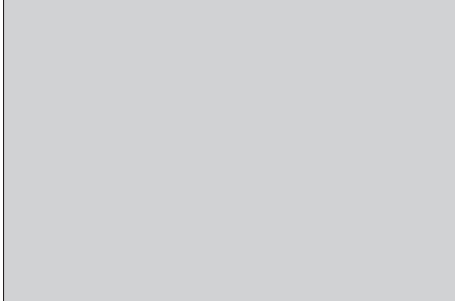

A-6023D-1GM-①
Printed in Japan
© 2001 Icom Inc.

Icom Inc.

1-1-32 Kamiminami, Hirano-ku, Osaka 547-0003 Japan